



NTSC U/C

PlayStation™



SLUS-00346
04-50016

TIGERSHARK™

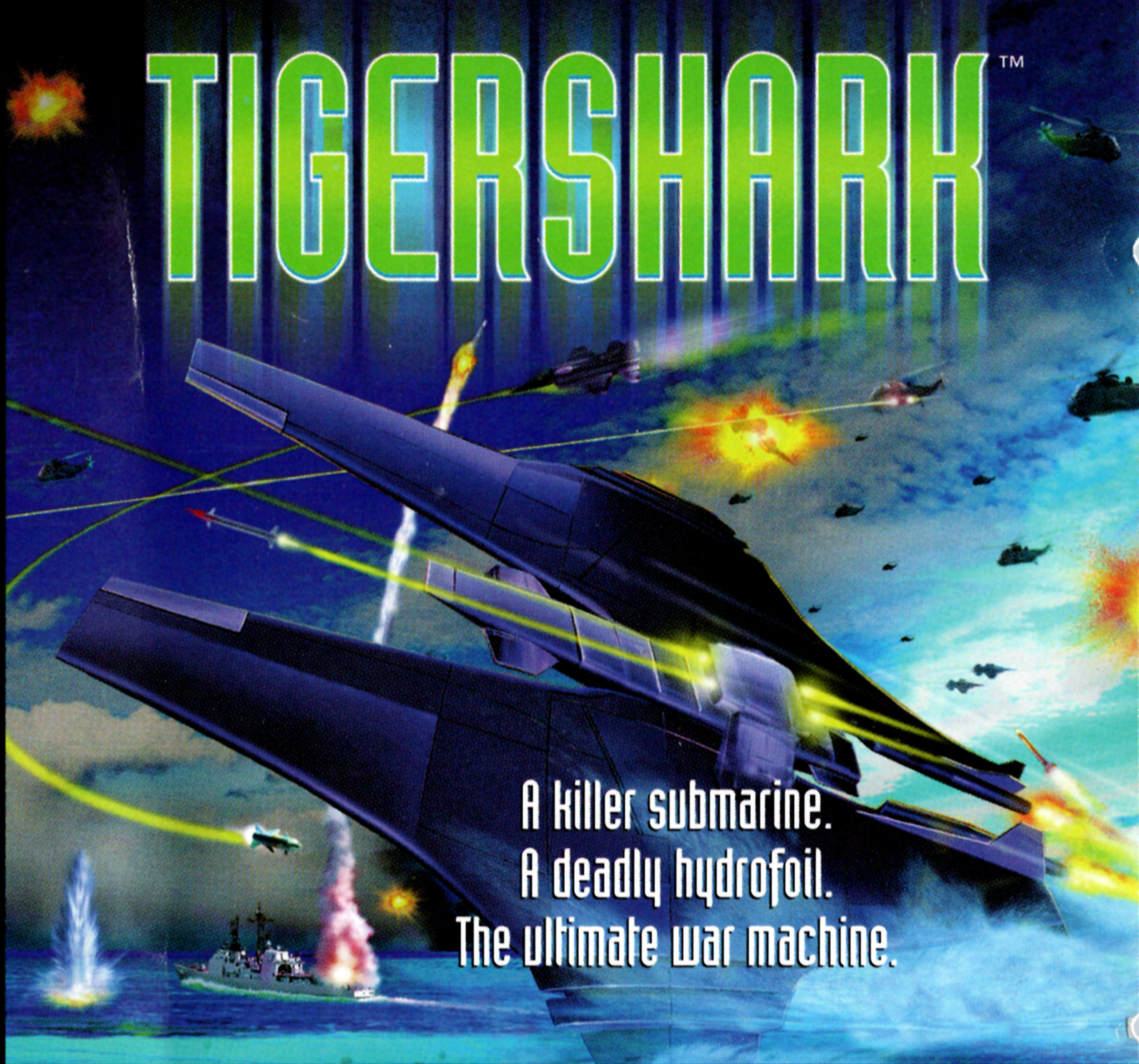

A killer submarine.
A deadly hydrofoil.
The ultimate war machine.



WARNING: READ BEFORE USING YOUR PlayStation™ Game Console. A very small percentage of individuals may experience epileptic seizures when exposed to certain light patterns or flashing lights. Exposure to certain patterns or backgrounds on a television screen or while playing video games, including games played on the PlayStation game console, may induce an epileptic seizure in these individuals. Certain conditions may induce previously undetected epileptic symptoms even in persons who have no history of prior seizures or epilepsy. If you, or anyone in your family, has an epileptic condition, consult your physician prior to playing. If you experience any of the following symptoms while playing a video game - dizziness, altered vision, eye or muscle twitches, loss of awareness, disorientation, any involuntary movement, or convulsions- **IMMEDIATELY** discontinue use and consult your physician before resuming play.

WARNING TO OWNERS OF PROJECTION TELEVISIONS:

Do not connect your PlayStation game console to a projection TV without first consulting the user manual for your projection TV, unless it is of the LCD type. Otherwise, it may permanently damage your TV Screen.

HANDLING YOUR PlayStation™ Disc:

- This compact disc is intended for use only with the PlayStation™ game console.
- Do not bend it, crush it or submerge it in liquids
- Do not leave it in direct sunlight or near a radiator or other source of heat.
- Be sure to take an occasional rest break during extended play.
- Keep this compact disc clean. Always hold the disc by the edges and keep it in its protective case when not in use. Clean the disc with a lint-free, soft, dry cloth, wiping in straight lines from center to outer edge. Never use solvents or abrasive cleaners.

TABLE OF CONTENTS

GETTING STARTED2
QUICK START4
GAME SETUP4
Start Mission4
Resume Mission4
Control Options5
Audio Options6
Difficulty Options6
SITUATION BRIEFING6
History6
Current Situation7
The Plan7
TIGERSHARK EXPERIMENTAL SUBFOIL7
Overview7
Surface Operations8
Subsurface Operations8
Viewscreens8
Ping9
Target Lock9
Hud9
System Regeneration10
Sensors10
Waypoint Indicator11
ARMAMENT11
Surface Ordinance11
Subsurface Ordinance12
THE ENEMY13
Russian Geothermal Taps13
Japanese Geothermal Taps13
Alert Zones14
Enemy Units and Weaponry14
TACTICAL ADVISORIES20
Mission One20
Mission Two20
SAVING A GAME21
STRATEGY AND TACTICS21
TECHNICAL SUPPORT22
CREDITS24
WARRANTIES25

GETTING STARTED

1. Set up your PlayStation™ game console according to the instructions in its Instruction Manual.
2. Make sure the power is off before inserting or removing a compact disc.
3. Insert the TIGERSHARK™ disc and close the CD door.
4. Insert game controllers and turn on the PlayStation™ game console. Follow on-screen instructions to start a game.

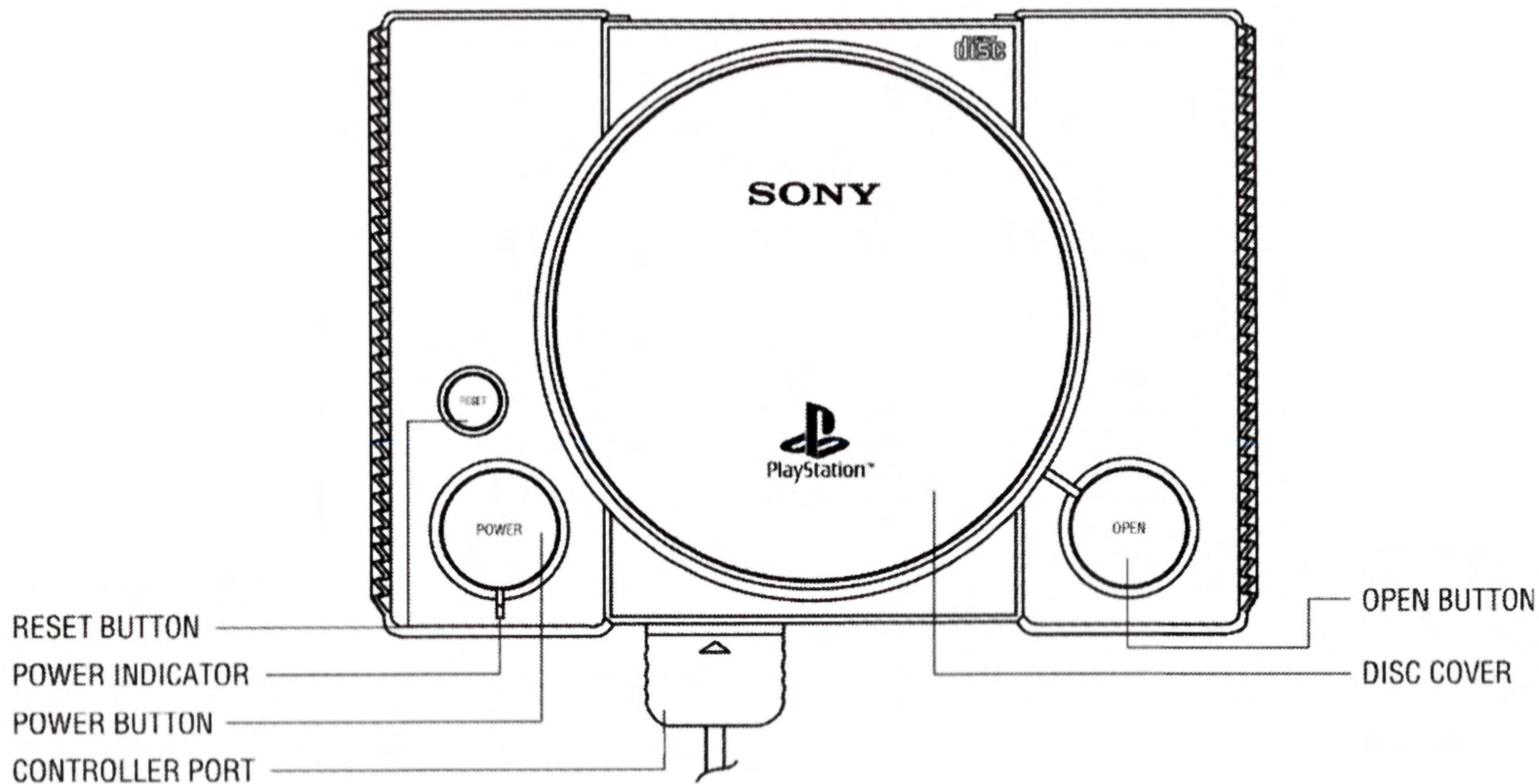

Front View

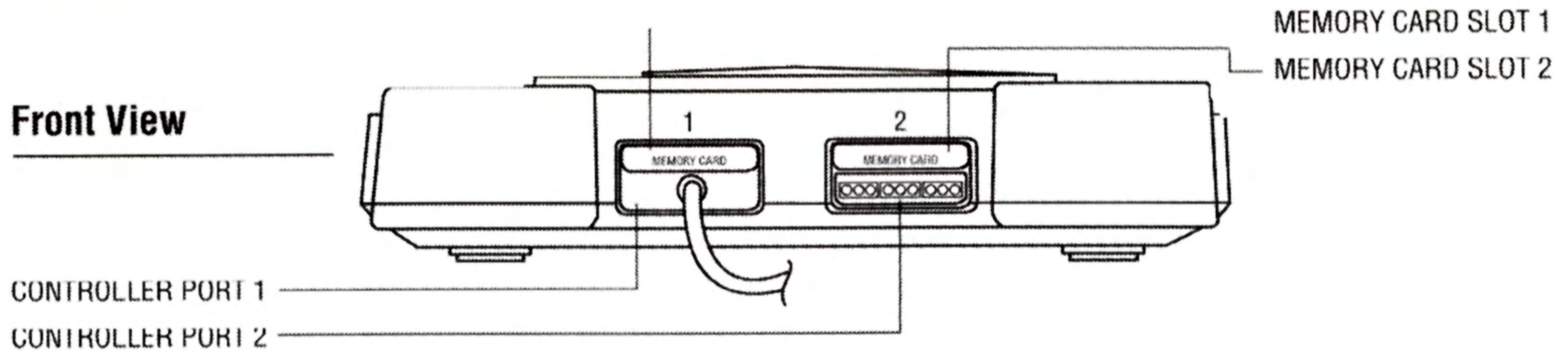

Front View

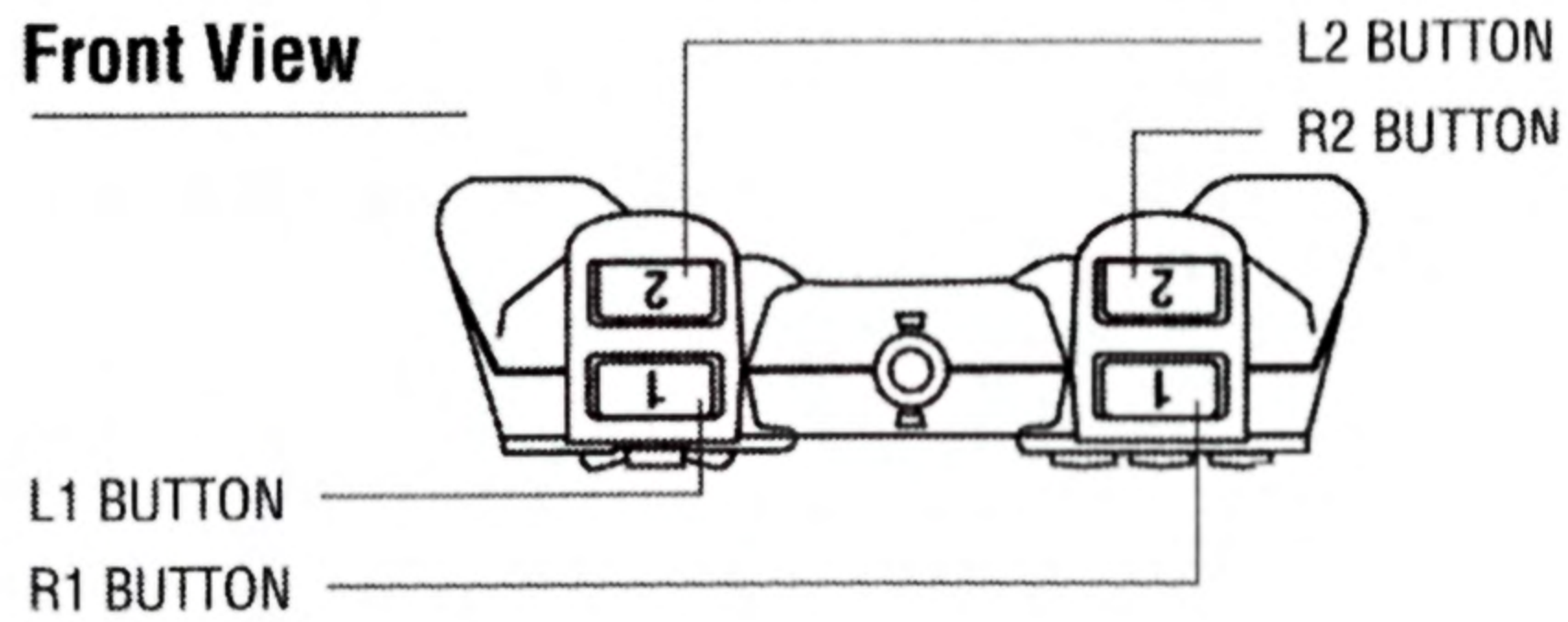

Top View

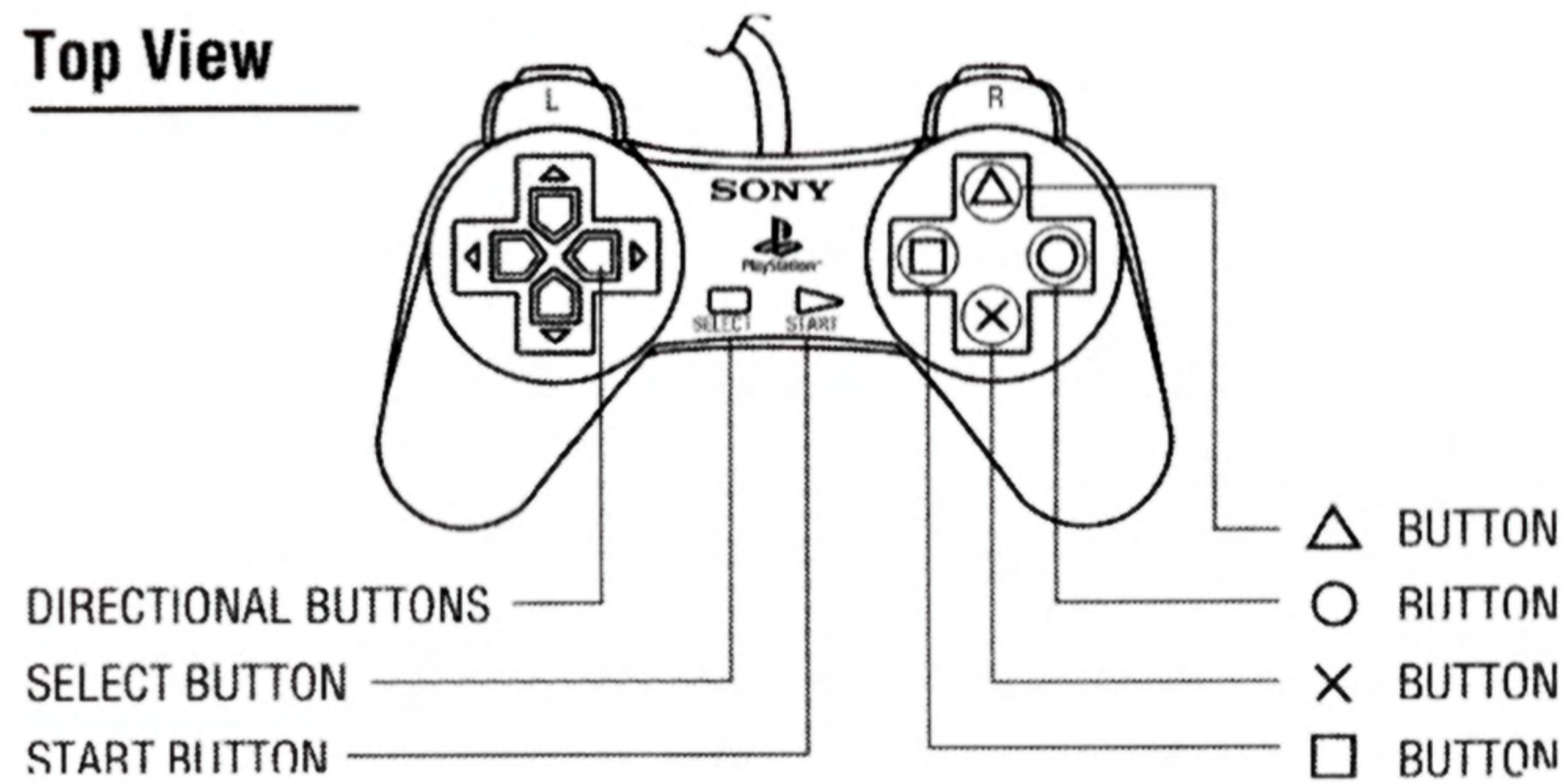

QUICK START

1. Press Start from the Main Screen to start Mission 1. After viewing the mission briefing, you will be launched into the first mission area.

2. Press R1+R2 to stop and get your bearings. The Message Display will direct you to your first objective: "Destroy Russian Sonar 1."

3. Locate the Threat display and steer toward it. The small arrow on the outer edge of the display points to your objective, a subsurface sonar installation. You can accelerate by pressing R1, and dive by pressing UP on the DPad to nose the ship down into the water.

4. Lock on to the target by pressing the O Button when the target is visible in the viewscreen. A colored status box appears around a locked target -- green for an undamaged target and yellow then red as damage accumulates.

5. Press the X Button to launch a homing torpedo (MK-65) as soon as you see the status box around the target.

6. Once you have destroyed the sonar station, watch the message display for further orders. You will be instructed to destroy two geothermal taps and to reset a third. Pay attention to incoming messages for additional mission objectives

7. When you have achieved all mission objectives, return to the Subcarrier Olympus for pickup.

Notes:

You can cycle through the different views at any time by pressing Select.

If you are attacked by enemy fighters while under water, use the □ Button to fire your Phased Plasma Repeater (PPR).

If your visibility is low under water, press the L2 button to "Ping" the active sonar. This will temporarily expose enemies on the sonar display and in the viewscreen, but will give away your location to everyone in the area.

GAME SETUP

Start Mission

This will be highlighted when you enter this screen. Press the Start or X Button to start the game.

Resume Mission

Highlight Resume Mission and press the X Button to access the Resume Mission Screen.

If there is no Memory Card inserted in your Playstation, you will see the Password Entry Screen. At the end of each successfully completed level, you will be presented with a five-character password. These passwords will allow you to resume play at the same place you left off. To enter a password, use the DPAD to select characters from the grid. Press the X Button to enter the character. Press the □ Button to back up one character. Press the △ Button to exit the screen without entering the password. When you have entered the password, press the Start Button to enter the completed password. If the password is valid, you will hear a confirmation tone. When the password is invalid, an error tone will be heard and the Resume Mission remains displayed.

NOTE: Entering the password "BUGGY" will display information on an upcoming n-Space game.

If you have a Memory Card inserted in your Playstation, you will see the Saved Game screen. The names of any existing saved games will be displayed. To load a game, highlight the game you wish to load and press the Start Button. Press the △ Button to exit this screen without loading a saved game.

If you have a Memory Card inserted in your Playstation, you can still enter passwords. To do so, press the ○ Button to switch to the Password Entry Screen.

Control Options

Highlight the Controls selection and press the X Button to access the Control Options Screen.

The current button mappings are labeled on the diagram of the controller. To change to a different control set, press Left or Right on the DPad.

In addition to the standard control sets, there are two additional variations available: Game/Flight mode and Auto-level/Manual mode.

Press the ○ Button to switch between Game and Flight modes. In Game mode, Up on the DPad will cause the ship to climb and Down will cause it to dive. In Flight mode, Up will cause the ship to dive and Down will cause it to climb.

Press the □ Button to switch between Auto-level and Manual modes. In Auto-level mode, Left and Right on the DPad will cause the ship to bank and turn simultaneously. In Manual mode, Left and Right cause the ship to roll without turning.

To turn, use Up and Down on the DPad to pitch the ship while rolled. This mode allows for increased maneuverability, but takes considerable practice to master.

Audio Options

The two sliders control the volume of the sound effects and music heard during the game. Choose a slider by pressing Left or Right on the DPad and adjust the levels with Up and Down. Press Start or X Button to exit the screen.

Difficulty Options

Tigershark has three difficulty modes and a Training Level. choose the difficulty setting you want with Up and Down on the DPad. Press Start or X Button to confirm your choice and exit the screen.

Training

The Training Ground is a special sealed test area used for developing mastery of the Tigershark systems against a variety of targets.

Milk Run

In this setting, the Tigershark has increased armor and weapon loads, there is no systems damage, and nearby explosions do no collateral damage. While this is the easiest play setting, it only allows access to the first six levels of the game.

Rock & Roll

In this setting, the Tigershark has standard armor and weapon loads. Propulsion, Weapons, and Sensor internal systems are vulnerable to critical damage, but will regenerate over time, and nearby explosions do collateral damage to the ship.

Good Luck!

In this setting, the Tigershark has less armor and standard weapon loads. Propulsion, Weapons, and Sensor internal systems are vulnerable to critical damage, and regenerating slower. Nearby explosions do collateral damage to the ship.

SITUATION BRIEFING

History

In the year 2060, the Japanese Government, desperate for new sources of power to accommodate their burgeoning population, approved the use of a radical new Geothermal Tap in the fault lines that ring Japan's coast. This network of energy taps would serve the dual purpose of providing tremendous amounts of energy while at the same time stabilizing the fault complex that had threatened Japan for millennia.

Initially all went well, but soon it became apparent that something had gone terribly wrong. A series of violent earthquakes shook the Japanese Archipelago and on August 21, 2064 large sections of the Japanese Islands fell into the sea as the weakened tec-

tonic plate they rested on collapsed. The resulting tsunami devastated the coasts of Asia and a large number of the islands of the South Pacific.

Nearly sixty percent of the Japanese population died in the span of minutes. The government was completely destroyed along with all of the country's armed forces.

The collapse of Japan was seen as an opportunity by the Russians. In a series of lightning strikes, they secured what remained of Japan. These strikes were totally unopposed and largely successful in only a matter of days.

Current Situation

It now appears that the entire cataclysm was actually engineered by one Russian commander. Admiral Dmitri Konstantin is commander of the submarine forces of the Russians. In the name of energy research, he built a series of his own Taps which he secretly linked to the Japanese devices. His goal was to learn to use the energy produced as a weapon. Our scientists believe that his devices destabilized the crust and led to the original cataclysm. Furthermore, it is believed that continued use of the taps is leading to the inevitable collapse of the Pacific plate and the possible destruction of life on earth.

The Plan

It is imperative that the Russian taps be destroyed and the situation stabilized. To that end, the experimental subfoil Tigershark is to be deployed on a top secret mission to secure the area. Intelligence has pinpointed the location of the critical geothermal installations. Your ship will penetrate the Russian defenses and take out all Russian Geothermal Taps. In addition, the Tigershark is armed with specially designed EMP torpedoes to be used to disable the Japanese Geothermal Taps. In addition to the above mission goals, it is to be considered a valid objective to find and terminate Konstantin himself if the opportunity presents itself.

THE TIGERSHARK EXPERIMENTAL SUBFOIL

Overview

The Tigershark Subfoil is a heavily armored attack vehicle with massive firepower and blazing speed. Moving with a combination of pulse jets, ducted fans and foils, the Subfoil can maneuver through even the most treacherous surface and subsurface terrain with ease.

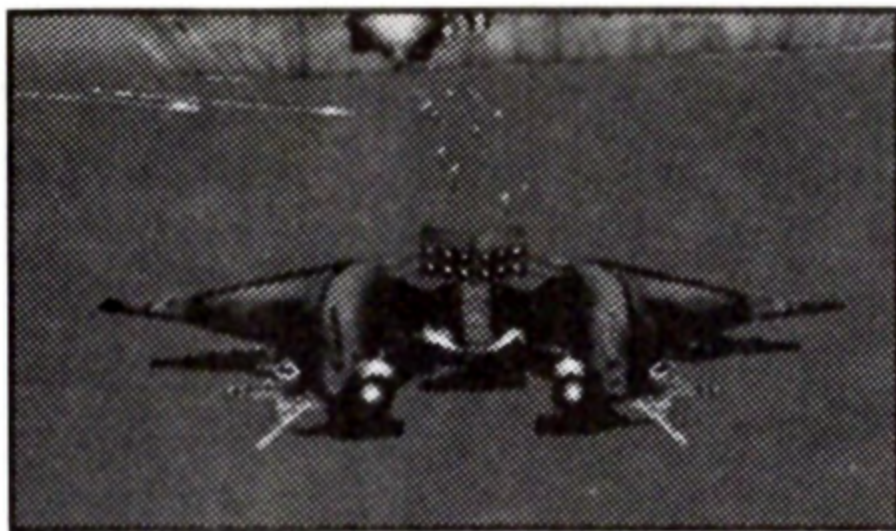

Surface Operations

When traveling on the surface, the Tigershark acts like a high speed hydrofoil. With its stabilizing wings extended and aerodynamic missile pod deployed, it is extremely stable yet maneuverable weapons platform. The main weapon in surface mode is the GAU-90 25mm Gatling Assault Cannon which fires depleted uranium shells. The Tigershark also carries various types of seeking and straight fire rockets and missiles. In addition to its high speed surface attack configuration, the Tigershark can transform itself into an extremely tough and speedy submarine fighter through the simple expedient of diving below the surface.



Subsurface Operations

In its subsurface configuration, the Tigershark's main weapon is the PPR-X Phased Plasma Repeater. In addition to this directed energy weapon, the Tigershark can carry a wide variety of torpedoes. Specific weapons loads will be optimized for each mission. When travelling below the surface, the Tigershark retracts its stabilizer wings and missile pod and becomes a sleek killing machine with full freedom of motion in all axes.

Viewscreens

Passive Acoustic Imaging System

Rather than depend on simple optical systems with their inherent limitations when used under water, the Tigershark uses a Passive Acoustic Imaging System (PAIS) to build a virtual reality display on the cockpit's wrap around viewscreen. This system paints an image of the surrounding area by analyzing the ambient sound environment to determine the characteristics of surfaces and shapes of objects in the environment. This allows the cockpit to be heavily armored while still providing a clear view of the surroundings. In addition, the PAIS display allows for three different views: first person, third person, and drop camera. In first person view, the PAIS simulates the view the pilot would expect to see out the "windshield." In the third person view, the PAIS uses a towed sensor array to create an image which includes an exterior view of the Tigershark. In the drop camera view, the PAIS system jettisons a sensor array out the rear of the ship. This array has a limited range and as such is mostly useful for getting an overview of the combat area - actual combat is not recommended using this view.



Ping

Since the PAIS is a passive system its range can be limited by a variety of environmental factors. This is displayed as a gradual dimming of detail at the far extent of its range. The range can be extended by "Pinging" or sending out a burst of precisely tuned sound to provide more data for the PAIS processor. When a ping is sent out, the terrain and objects surrounding the Tigershark will be drawn much more clearly and the outer range will be moved out temporarily. This will enable both visual and sonar target location at extreme range. The drawback is that it also will alert all local enemy forces to your position.

Target Lock

It is possible to "Lock On" to a vehicle or installation. The item thus selected will be displayed with a selection box drawn around it in one of several colors depending on its type and status. Any enemy or other potential target will be drawn in Green. Any Friendly or other no-fire selection will be drawn in blue. In addition to allowing you to see the enemy at a greater distance, the boxes serve two additional purposes. First, any enemy locked on to is the current target for any homing torpedoes or missiles you launch - whether or not you are point in their direction. Lock is only lost if the enemy passes out of range or the Tigershark dives or surfaces. Second, the box color will indicate damage to the target. A damaged target will show as yellow then red as it sustains damage.

HUD

The PAIS can superimpose a Heads Up Display (HUD) over the virtual world view. This HUD includes a variety of systems and tactical data.

Weapons Status - Displays the currently selected torpedo or missile, ammo load of cannon or recharge level of PPR, and the count of the currently selected torpedo or missile.

Systems Status - Displays status for three internal systems: Propulsion, Sensors, and Weapons. The indicators will change color from green to yellow to red as they are damaged. Systems damage may affect a variety of performance characteristics of the Tigershark and needs to be avoided if at all possible.





Armor Status - Indicates the amount of hull damage the Tigershark has sustained. The bar counts down to the middle. When the bar is gone, one more hit will kill the ship.

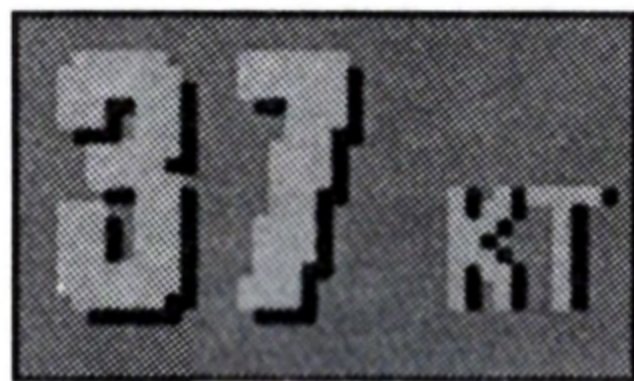

Speed Indicator - Speed in knots. Red numbers indicate reverse movement.

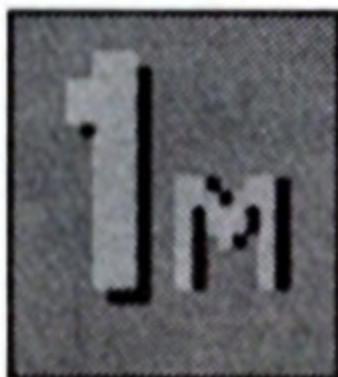

Depth Indicator - Depth in Meters.



Surface Indicator - The small arrow always points up toward the surface.

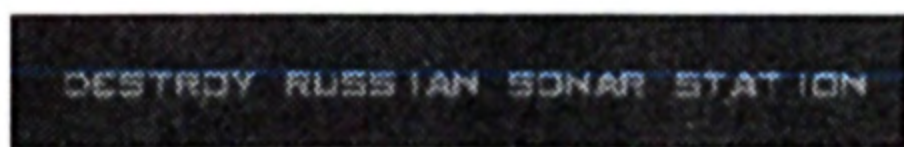

Message Display - Watch this area for important mission information including waypoints, alerts, warnings, and special orders.

Systems Regeneration

Internal systems have self-repair circuits and machinery which will bring them back on line after some time passes. Once a system is damaged it will only be able to repair itself to yellow status.

Sensors (Radar/Sonar)

Standard Display

YELLOW	Enemy subsurface vehicles
GRAY	Enemy surface vessels
PINK	Enemy emplacements
GREEN	Waypoints
RED	Currently selected target
WHITE	Special Items
FLASHING	Enemy Sonar and Radar
BLUE	Flying Enemies

Waypoint Indicator

The Waypoint indicator is the small arrow on the perimeter of the sonar dial. It always points in the direction of the current mission waypoint. Since there is no vertical component to the display, the arrow may be indicating a location above or below your current position.

ARMAMENT

Surface Ordnance

GAU-90 25mm Gatling Assault Cannon (Utility)

The Navy standard light armor piercing weapon of the twenty-first century. With a muzzle velocity of 1100 meters per second, the Depleted Uranium Sabot rounds easily lance through all but the most heavily armored targets.

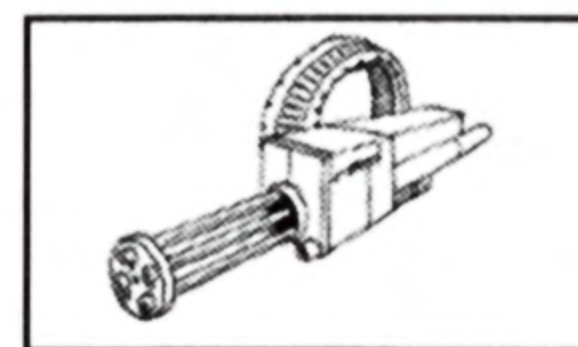

SR-70 70mm Strike Rocket

A light rocket usually found in aircraft rocket pods. The fast rate of fire and the long range of these unguided munitions make them a favored weapon for engaging slow or stationary targets.

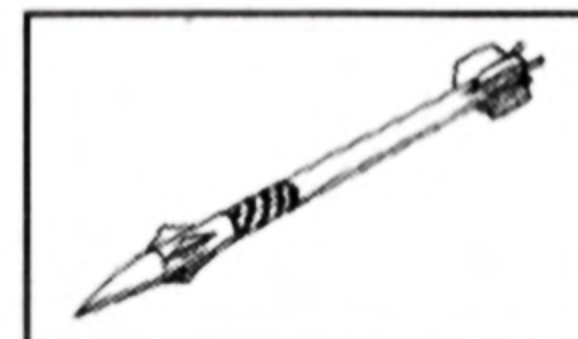

SR-90 90MM Strike Rocket

A heavier rocket with a heavier payload and slightly slower re-fire rate. Useful for engaging Radar installations and Heavy Cruisers. The heavier warhead limits its range compared to the SR-70



SM-25 Firespike Fire and Forget Missile

A highly capable missile whose advanced electronics lock on and follow a target until the sustainer burns out or it strikes the target. With a substantial warhead and a prolonged flight time, it is a superb strike weapon.

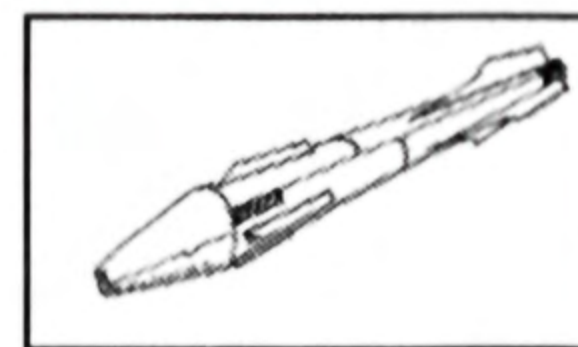

SM-19 Firefall Cluster Munitions Dispenser

An extraordinarily effective weapon capable of saturating a large area with self-forging armor piercing munitions. The carrier missile climbs over the target to a height of 200 meters. Once this point is reached, the carrier body ruptures, scattering bomblets over a wide area. As the submunitions reach a 50 meter height above the target, they explode, creating an armor piercing plasma jet that can burn through 800mm of armor plate.

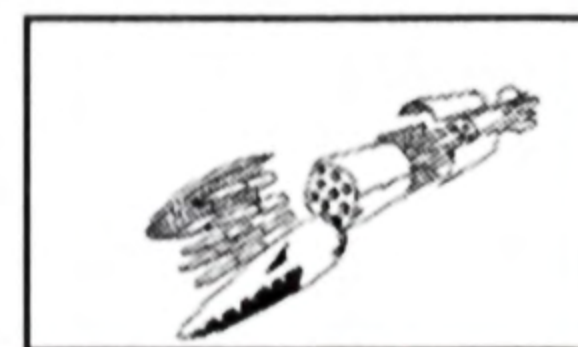

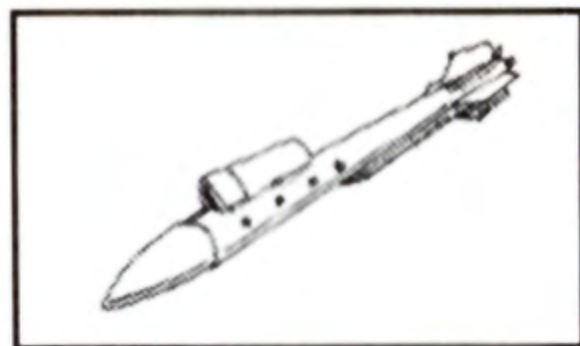

ECM-9000 Electronic Countermeasures Missile

This Missile has an extremely sophisticated Jamming/Lure Generator that analyses the capabilities of missiles tracking the Tigershark and then mimics the thermal, magnetic and radar signature most appealing to the attacking missiles.

Subsurface Ordnance

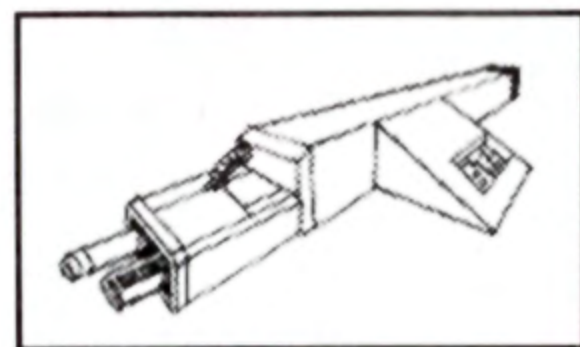

PPR-X Phase Plasma Repeater

A new and lethal weapon in the Tigershark's arsenal is the Phased Plasma Repeater. An internal laser array fuses a Sphere of copper into a Plasma/fusion state, the array then pulses in the x-ray spectrum, vaporizing the water in the launch path of the plasma round, the round then follows the momentary vacuum corridor at a speed in excess of 2000 meters per second. Limited only by the speed of the round before the carrier tube collapses, the PPR-X can burn through a meter of cast armor plate, setting off internal explosions and punching through pressurized hulls with ease.

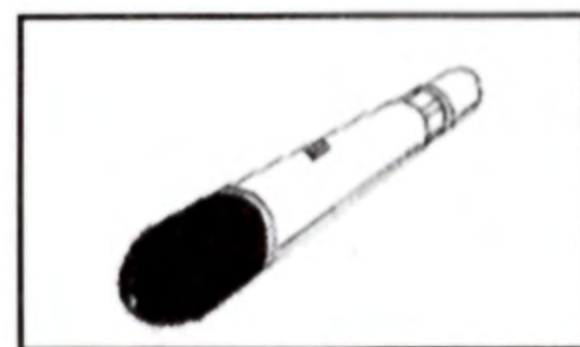

MK-60 Mark Sixty Heavy Weight Non-homing Torpedo

The U.S. Navy Standard explosive shaped charge torpedo. With a long range and no jammable guidance, these munitions are useful for attacking subsurface installations and Large attack submarines.



MK-68 Mark Sixty Eight Heavy Weight Non-homing Torpedo

This straight running torpedo is similar in usefulness to the MK-60 with the added benefit of much higher warhead yield.

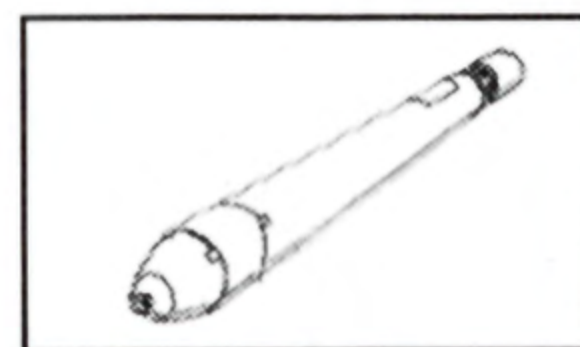

MK-65 Mark Sixty Five "Piranha" High speed Homing Torpedo

The Standard VLF link Command guided Homing Torpedo for the U.S. Navy, the MK-65 is very fast with a heavy warhead and superb range.

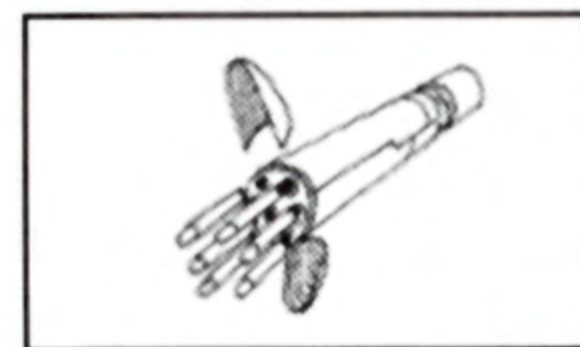

MK-90 Mark Ninety "SWARM" Torpedo

The SWARM (Seeking Warhead Area Munitions) Torpedo separates after launch into multiple projectiles that begin high speed runs toward their target. Their characteristic "butterfly" homing pattern is optimized to defeat the evasive maneuvers of enemy Subfighters.



MK-77 Mark Seventy Seven "ARCLIGHT" Disruption Torpedo

This experimental weapon homes on its target and releases an Electromagnetic Pulse into the surrounding water. This has a devastating effect upon unshielded electronics, causing them to burn out, and often detonates volatile internal fuel supplies or ammunition. With a large area of effect, this weapon is useful for engaging groups of subfighters. It is even capable of temporarily disabling large submarines.

EMP Torpedo

This torpedo was originally designed to disable early warning sensors for the Russian navy in order to attack Submarine bases. Once the scale of the Japanese crisis became apparent, they were modified to release an Electromagnetic pulse on contact that would effectively disable the electronic control systems on the Japanese Geothermal Tap.

ECM "Pied Piper" Torpedo Lure

The Pied Piper ECM Drone uses sophisticated acoustic jammers to confuse and lure enemy torpedoes. Once deployed, the drone spirals away, drawing any seeking weapons in the area along with it.



THE ENEMY

The enemy is a portion of the Russian Pacific Fleet under the command of Admiral Dmitri Konstantin. Since you will be attacking his fortified installations, you will be facing considerable opposition. Each of the Japanese and Russian geothermal taps is sure to be heavily defended by sonar and or radar installations, fixed weapons emplacements, subfighters, surface ships and helicopters.

Russian Geothermal Taps

One of the primary mission goals will be the destruction of the Russian Geothermal Taps. These taps are smaller and less powerful than their Japanese counterparts, but present the greatest danger to mankind due to their unsafe and inefficient design. It is believed that continued use of these taps may lead to a complete collapse of the Earth's crust over most of the Pacific Basin. The taps are sure to be heavily defended and are heavily armored. Attack Russian Taps from a distance with any and all weapons you have available. Note, however, that MK-77's and EMP torpedoes are ineffective against these hardened installations.

Japanese Geothermal Taps

The second goal of the missions is to reset or fuse the controls of the Japanese Geothermal Taps which survived the disaster which sank Japan. These taps harness many times the energy of their Russian counterparts and must be left intact to prevent further destabilization of the crust. Due to the huge amount of energy these taps are drawing directly from the Earth's mantle, destruction of one of them will lead to the immediate destruction of all vehicles in the vicinity - and possibly to the end of all life as we know it. Use your EMP torpedoes to fuse the control systems of these taps and to shut down the magma flow to a safe level.

Alert Zones

Many areas in the enemy territory are protected by sonar and or radar. When you enter such a zone, you will be in great danger. When the alert zone is active, enemy plasma installations can intercept your torpedoes, all enemy fire rates are increased, and enemy defensive systems work at increased efficiency levels. In short, things will be VERY hot. Whenever possible, take out sonar and radar installations as soon as possible before you do anything else in a mission. Sonar and radar are identified in your sonar display as a flashing rectangle.

Enemy Units and Weaponry

Surface Light Units:

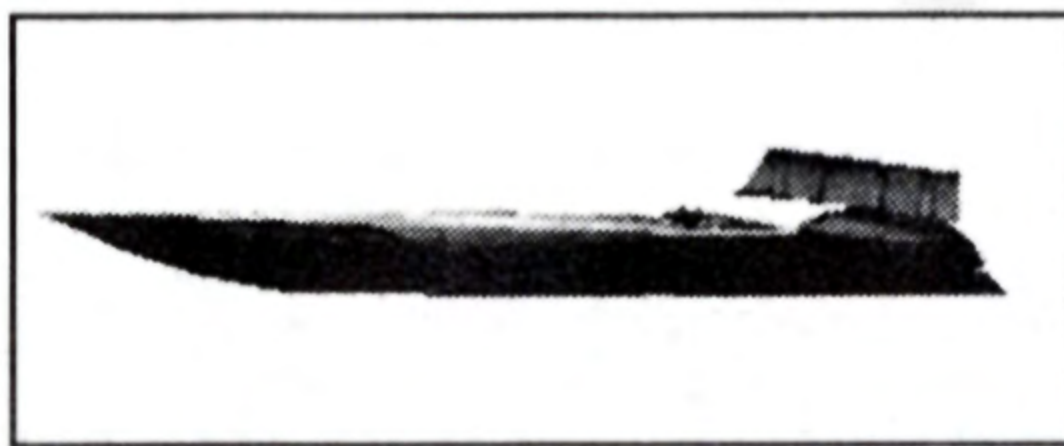

Armament: SS-N-4 Surface to Surface missile launchers; Ppsh-23mm Cannon

History: The Tarantul is the standard coastal defense boat for the Russian Navy.

Riga II

Length: 20 meters

Displacement: 100 Tons

Speed: 35 knots

Armament: SS-N-4 Surface to Surface missile launcher; Ppsh-23mm Cannon

History: The Riga II is the standard light patrol unit of the Russian Navy.

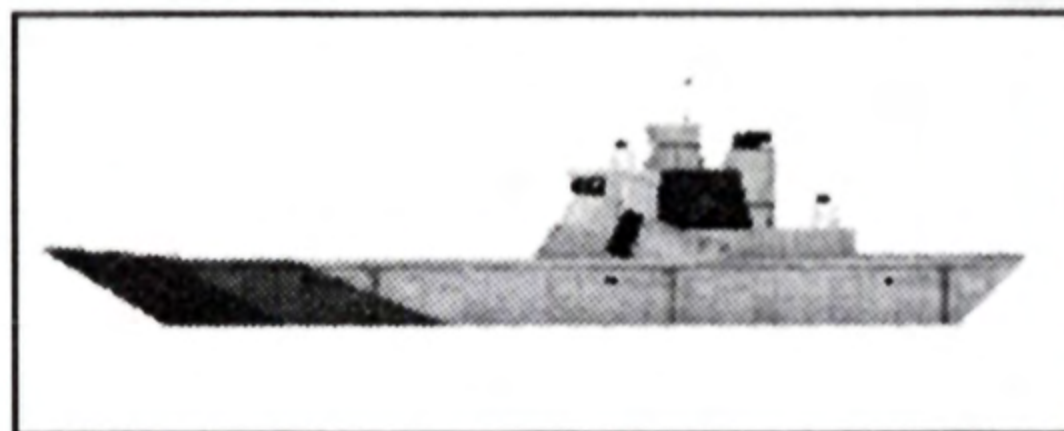

"Tarantul" Class Missile Corvette

Length: 58 meters

Displacement: 580 tons

Speed: 35 knots

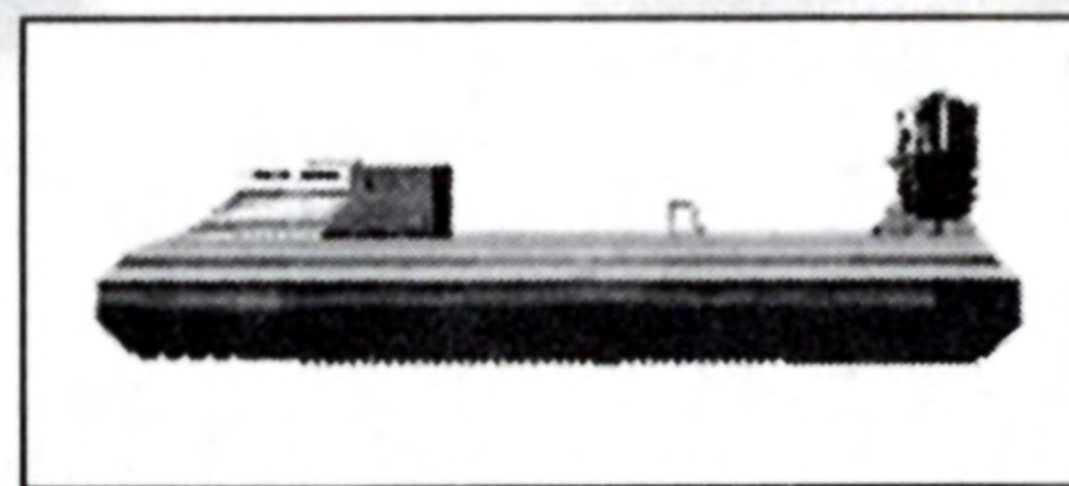

"Aika" class Attack Hovercraft

Length: 50 meters

Displacement: n/a

Speed: 35 knots

Armament: Ppsh-23mm Cannon

History: The Aika is an extremely agile and robust fast attack platform. Because it is a hovercraft, it is very difficult for submerged vessels to detect.

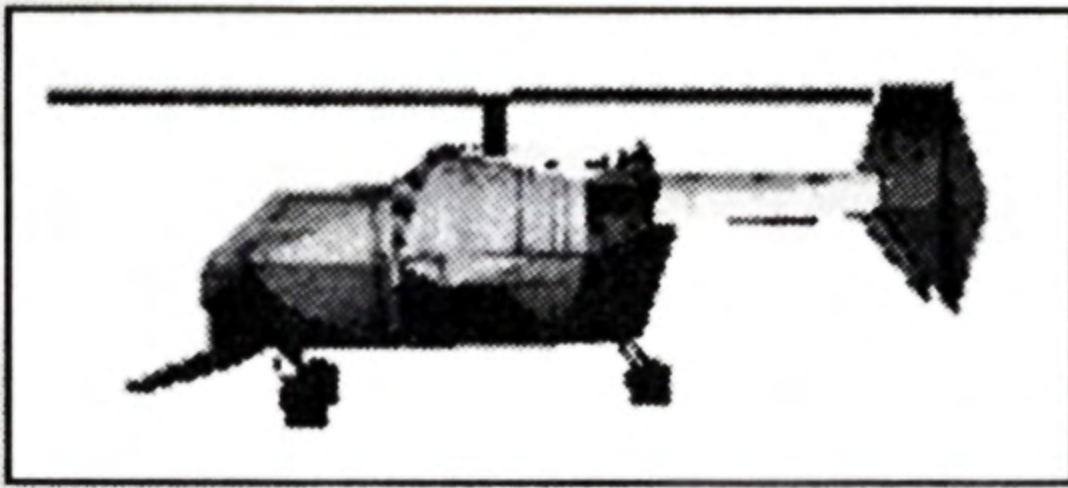

Kamov "Horus" class Anti submarine Helicopter

Length: 15 meters

Speed: 60 knots

Weight: 4 tons

Armament: Ppsh-23mm Cannon

History: The Horus is the standard antisubmarine helicopter of the Russian Navy.

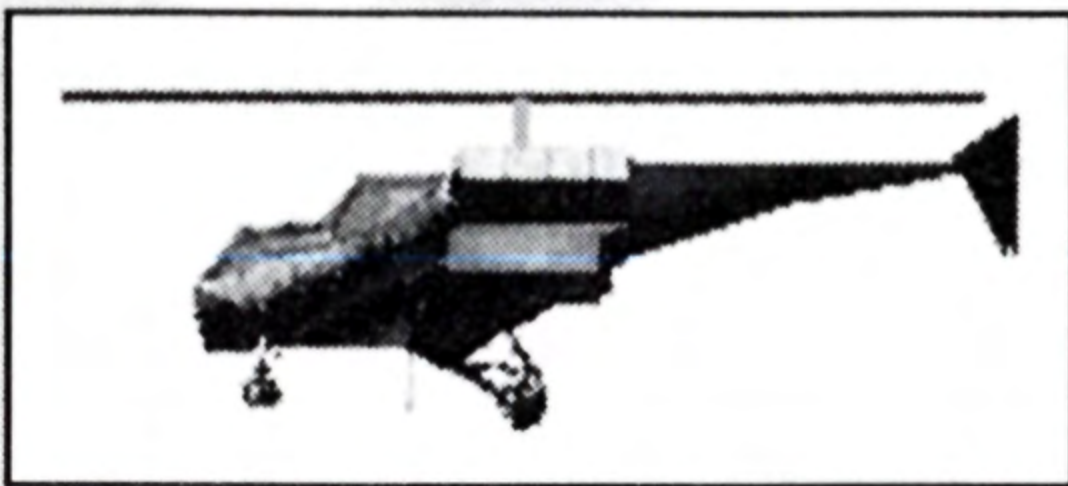

Kamov "Hatchet" class Attack Helicopter

Length: 15 meters

Weight: 3.25 Tons

Speed: 70 Knots

Armament: AS-9 Air to Surface
Missiles

History: The Hatchet is a versatile Attack Helicopter that has been optimized for Anti ship missions using missiles and cannon.

Surface Medium Units:

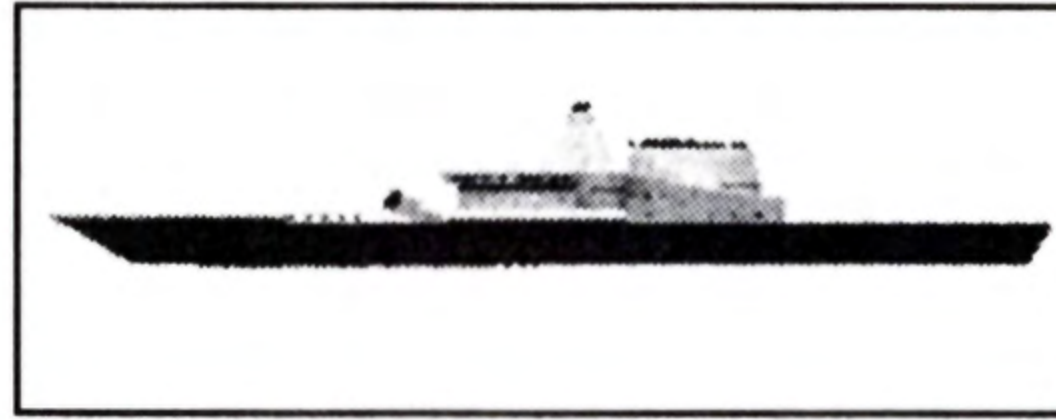

"Chapayev" class light antisubmarine cruiser

Length: 155 meters

Displacement: 7500 tons

Speed: 25 knots

Armament: SS-N-9 Surface to Surface
missile launchers; Depth Charges

History: As the Standard Antisubmarine Platform of The Russian Fleet, the Chapayev class has a wide variety of weapons at its disposal.

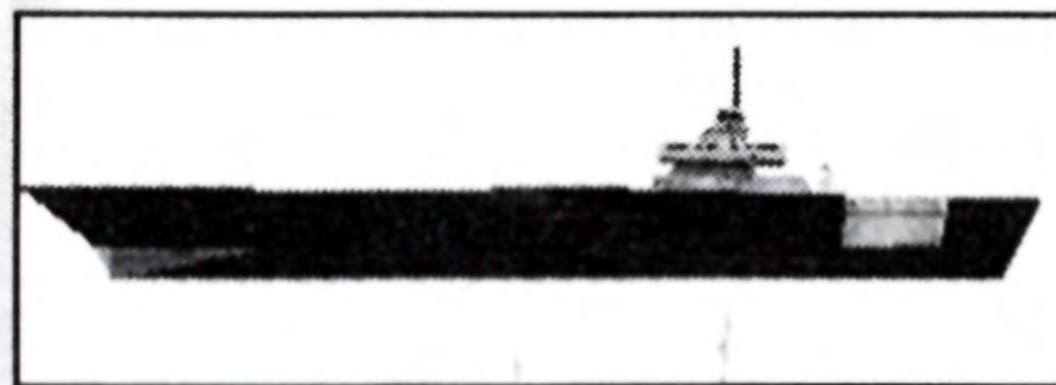

CVN-8 "Tbilisi" Class Fighter Carrier

Length: 300 meters

Displacement: 65000 tons

Speed: 25 knots

Armament: Up to 48 aircraft of various types.

History: The Tbilisi CVN is the last of a dying Breed. Vulnerable to Stealth Missile and Submarine attacks, this ship is still useful as a command and control platform for invasion forces. Most of her Aircraft are now helicopters of various types.

Underwater Light Units:

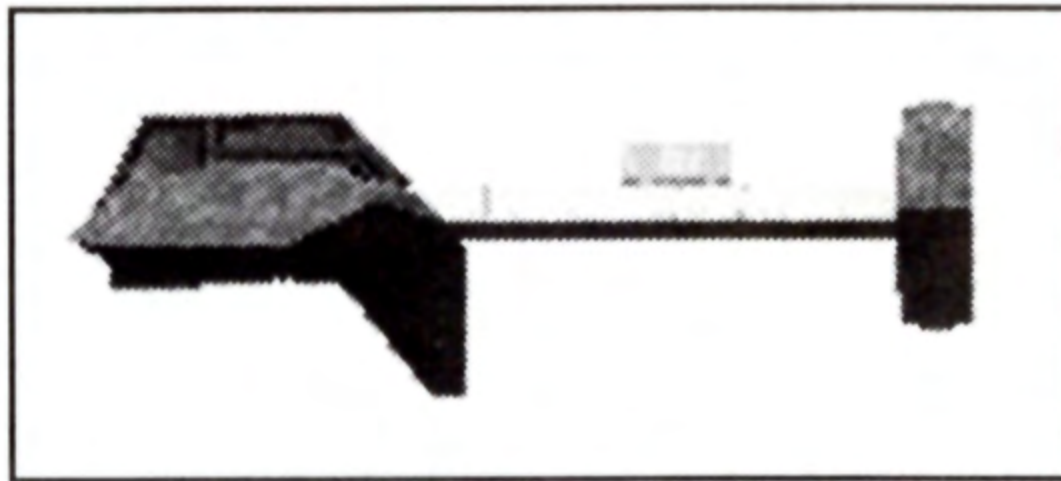

SS-1 "Raketny" Light Tactical Subfighter

Length: 10.25 meters

Displacement: 100 tons

Speed: 25 knots submerged

Armament: PL-2 Plasma Accelerator

History: The SS-1 was the first Subfighter deployed by the Russian Navy in large numbers. While not as fast or well armored as later types, the SS-1 is very agile and simple to maintain.

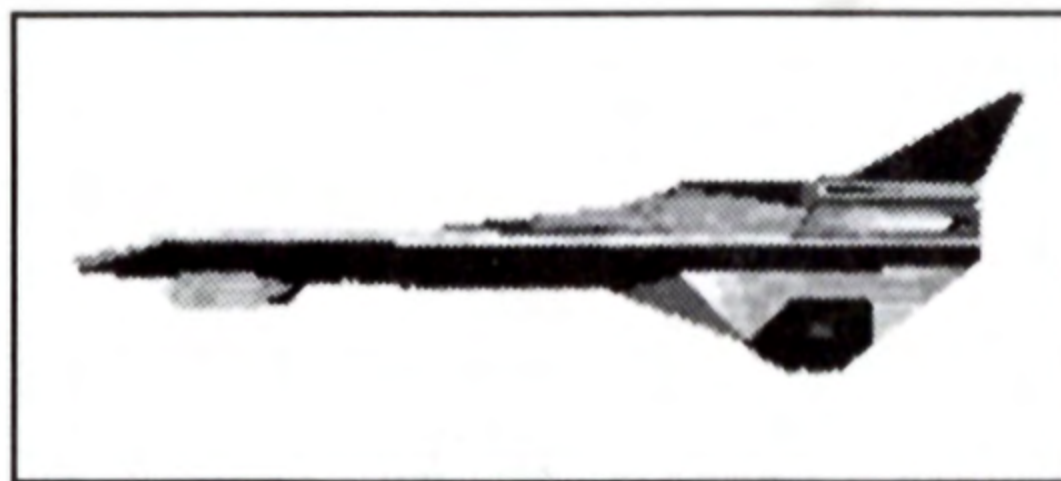

SS-3B "Mirka" Heavy Tactical Subfighter

Length: 14 meters

Displacement: 150 tons

Speed: 35 knots submerged

Armament: PL-2 Plasma Accelerator

History: The SS-3B is the most successful mass production design fielded by the Russian Navy.

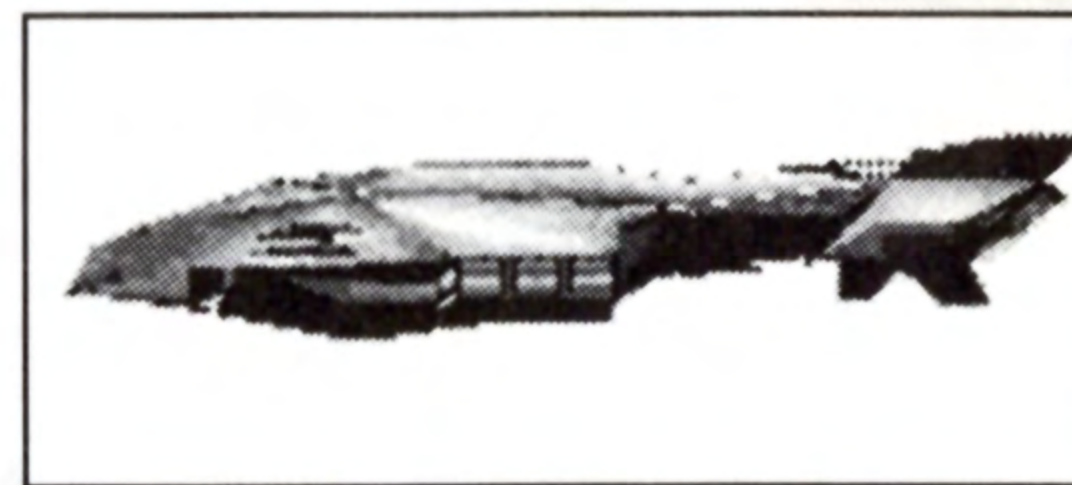

"Konovalov" class Deep Submergence Submarine (Tactical)

Length: 15 meters

Displacement: 250 tons

Speed: 15 knots submerged

Armament: ST-8 Heavy weight Torpedoes

History: The DssVn-K is an engineering submarine used by Russia for mine hunting and deep construction work.



SS-X "Konkurs" class Tactical Fighter (Experimental)

Length: 15 meters

Displacement: 125 Tons

Speed: 40 Knots submerged

Armament: ST-9 Torpedoes; PL-2 Plasma Accelerator

History: The SS-X is an advanced design being field tested in very limited numbers by the Russian Pacific Fleet.

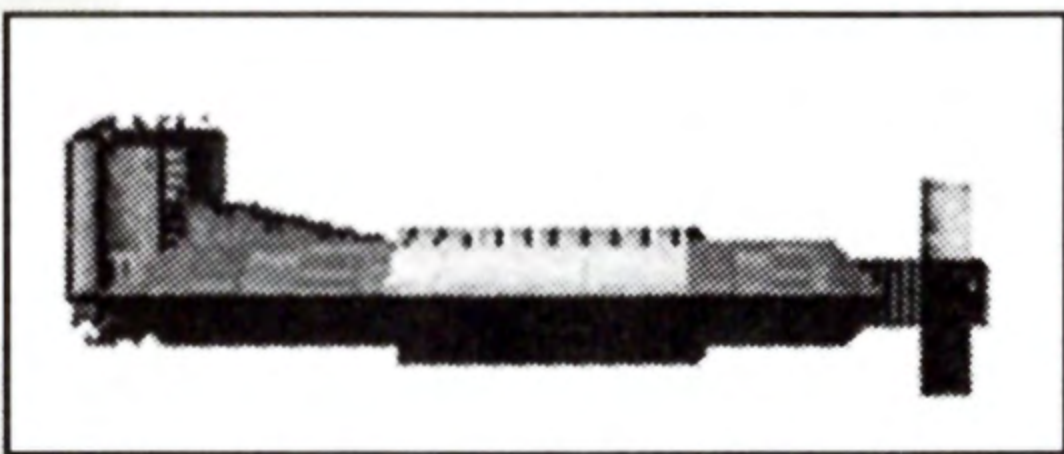

SE-20 Escort Submarine

Length: 25 meters

Displacement: 225 Tons

Speed: 30 Knots submerged

Armament: ST-9 Torpedoes (turreted)

History: The SE-20 is a light escort submarine used for defensive patrols and area defense.

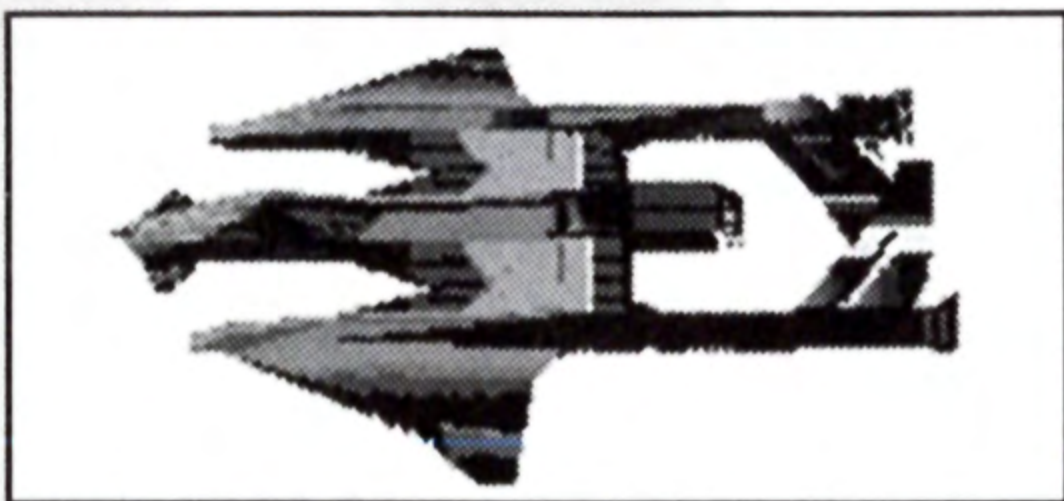

SSHM-Prototype

Length: 15 meters

Displacement: 25 Tons

Speed: 45 Knots surface/35 Knots submerged

Armament: Ppsh-23mm Cannon, Micro Laser, SS-N-9 Missiles, ST-9 Torpedoes, and Countermeasures.

History: The SSHM Prototype is the Russian's stab at constructing a Tigershark style Subfoil. The Russian Navy acquired a set of plans from the ruins of the MitsuKoshi Labs in now-sunken Tokyo. The Japanese Corporation had been involved with the Holographic Interface systems used in the Tigershark Prototype.

Medium Units:

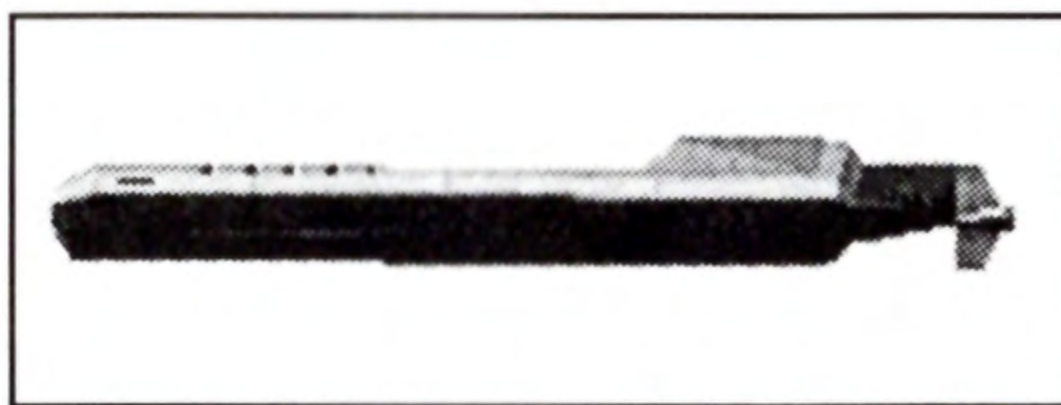

SSN-90 "Akula Nova" Medium Attack Submarine

Length: 82 meters

Displacement: 3500 tons

Speed: 25 knots submerged

Armament: Torpedo Tubes with ST-8 Heavyweight Torpedoes; Countermeasures

History: The SSN-90 is the mainstay of the Russian submarine fleet. Relatively quiet and capable of diving to great depths, it is a versatile attack platform (even if outdated by Western Standards.)

Heavy Units

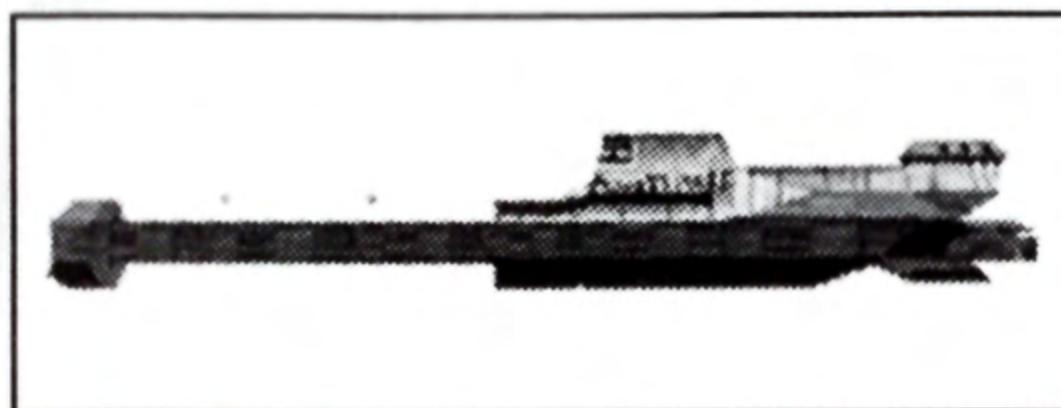

SSVN-1 "Kruschev" class Submarine Fighter Carrier

Length: 170 meters

Displacement: 29000 tons

Speed: 20 knots submerged

Power Source: Fission Plant

Armament: Torpedo Tubes with ST-8 Heavyweight Torpedoes; Countermeasures

Small Craft: Up to 8 SS-3B "Mirka" class Subfighters
 History: After the U.S. Navy deployed the world's first Submarine Fighter Carrier (SSVN-001 USS Olympus), The Russians furiously began converting antiquated Typhoon class SSBN's for a similar role.

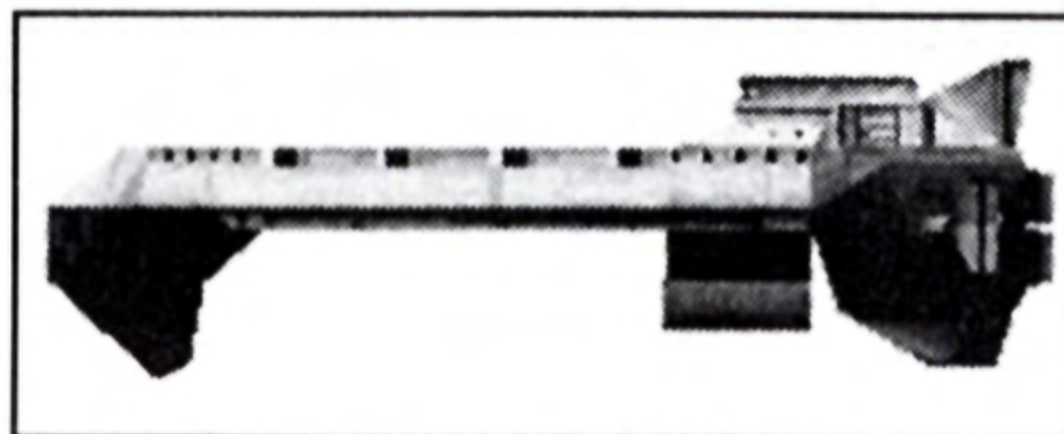

SSVN-2 "Czar" Class Submarine Fighter Carrier

Length: 200 meters
 Displacement: 30000 tons
 Speed: 25 knots submerged
 Power Source: 2x Fission Plants
 Armament: Torpedo Tubes with ST-8 Heavyweight Torpedoes; Countermeasures
 Small Craft: Up to 12 SS-3B "Mirka" class Subfighters
 History: The new "Czar" class SSVN represents an extraordinary technical leap in Russian Naval Design. Capable of fielding nearly as many fighters as a U.S. Olympus class, the SSVN-2 was clearly designed to be able to engage U.S. Subcarrier groups toe to toe.

Other Units

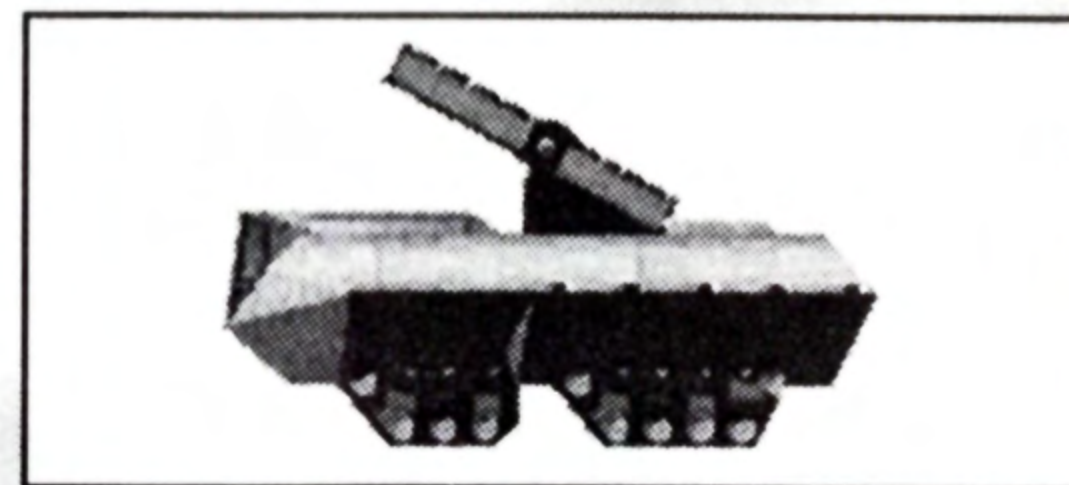

Subsurface Torpedo Crawler

Length: 10 meters
 Displacement: 75 tons
 Speed: 5 knots submerged
 Power Source: Lithium Energy Cell
 Armament: ST-9 Torpedoes
 History: The crawler is a modified Russian Cable laying and maintenance vehicle for Seabed use.

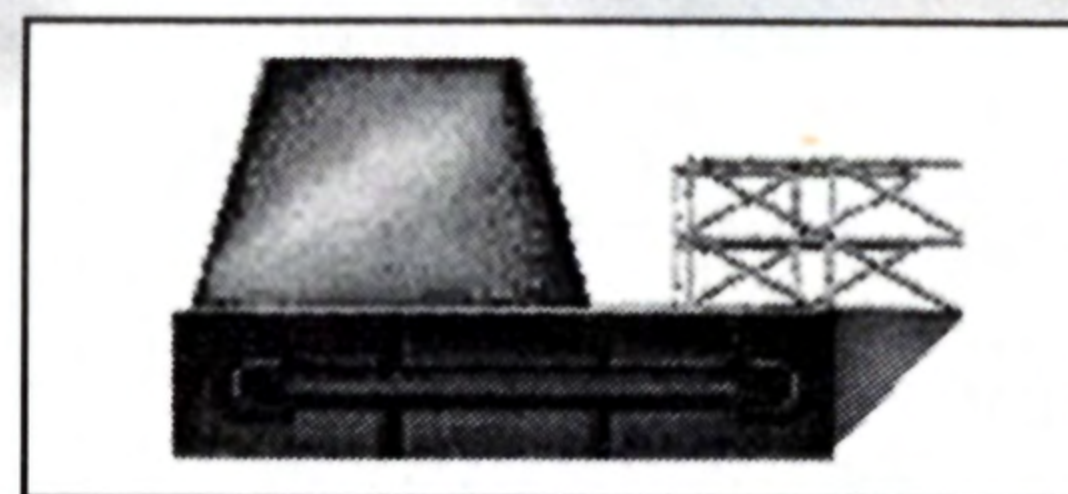

Drone Launcher

Length: 8 meters
 Displacement: 50 tons
 Speed: n/a
 Power Source: Lithium Energy Cell
 Armament: Suicide Drones
 History: The Drone Launcher ejects drones which function like slow torpedoes with the addition of a defensive loitering capability.

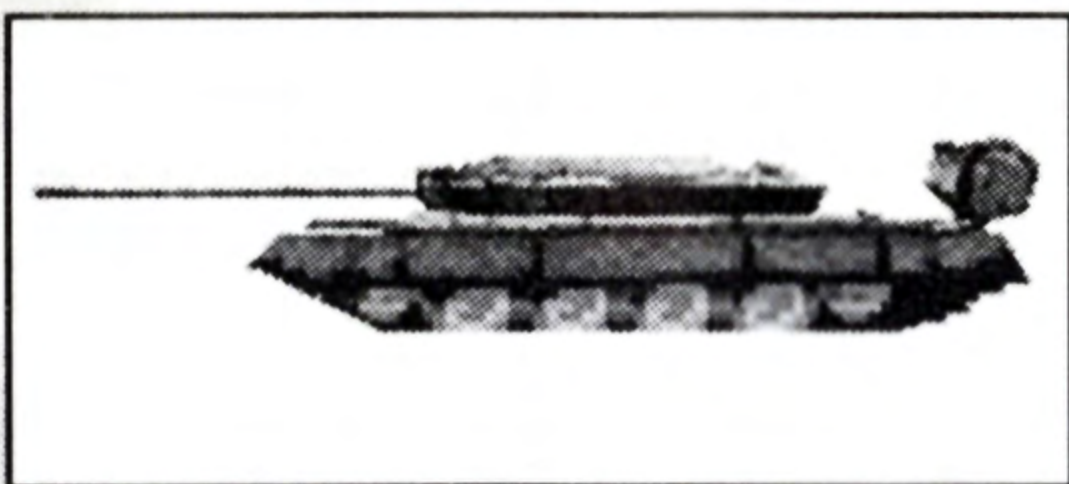

T-36R Main Battle Tank

Length: 7 meters

Displacement: 60 tons

Speed: 25 knots

Power Source: Diesel Engine

Armament: 122mm Heavy Cannon

History: The T-36R is the Main Battle Tank of the Russian Armed Forces.

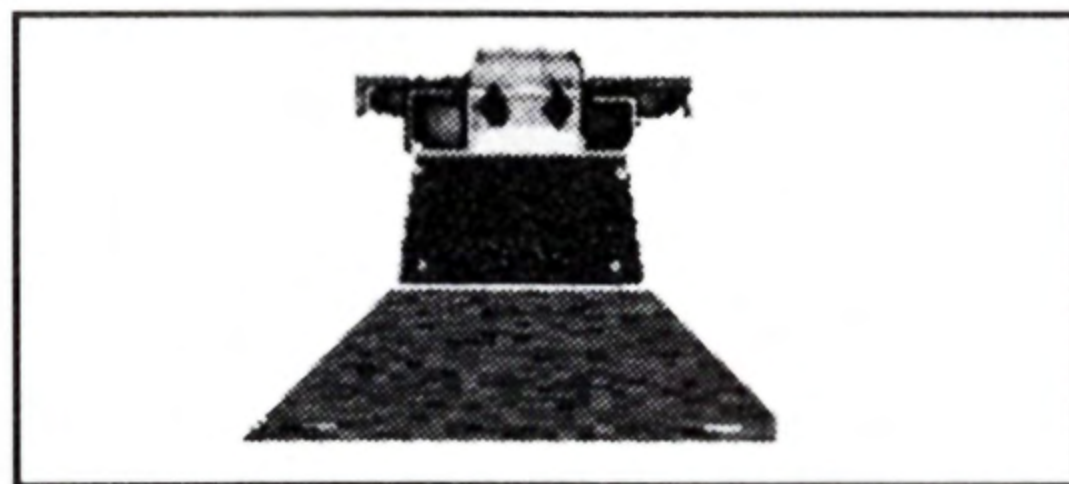

Gun Emplacement

Length: 3.5 meters

Displacement: 100 tons

Speed: n/a

Power Source: Lithium Energy Cell

Armament: Ppsh-23mm Cannon

History: The Gun emplacement is a Standard Coastal Defense battery.



Torpedo Emplacement

Length: 10.5 meters

Displacement: 100 tons

Speed: n/a

Power Source: Lithium Energy Cell

Armament: ST-9 Torpedoes

History: The Torpedo Emplacement is used by the Russian Navy for area point defense.



Subsurface Plasma Emplacement

Length: 6 meters

Displacement: 100 tons

Speed: n/a

Power Source: Lithium Energy Cell

Armament: PL-9A Point Defense Plasma accelerator

History: The Plasma emplacement is used to shoot down incoming torpedoes and to engage enemy subfighters within their zone of control. Destroying their Associated sonar will defeat their Torpedo interception capability.

TACTICAL ADVISORIES

Mission One

Proceed to the first waypoint (a submerged Sonar installation) by the directional arrow on the Threat display until you locate the Sonar. Each Sonar in the game controls an area of the battle zone, allowing enemies to more easily acquire and attack you. Destroy the Sonar by shooting it several times with the Phased Plasma Repeater (PPR). Turn left and you will see the second objective, the first Russian Geothermal Tap. Be wary of a stationary Plasma Turret nearby as well as an approaching Attack Submarine (Akula SSN). Destroy the Tap. Proceed toward waypoint three, a second Sonar. Weave through the buildings to provide cover and destroy the second Sonar. Turn right, select an EMP torpedo as your secondary weapon. Proceed to the Fourth Waypoint, a submerged Japanese Tap. Destroy the Plasma turret near the Tap with your PPR and then Fire an EMP torpedo directly at the Tap. If you hit, a field of Electrical energy will bathe the Tap, shutting it down. Surface, and follow your waypoint arrow to the fifth Waypoint, a Russian Tap on the Surface. This area is on a shallow shelf where you will be unable to dive. First attack the Nearby Cruiser by firing a volley of SR-70 Rockets into it until it sinks. Turn toward your final objective, select it as a target and fire your SM-25 Missiles at it until it is destroyed. If necessary you can also engage targets with Cannons. After the Last Tap is destroyed, follow the Waypoint arrow to the Subcarrier Olympus for extraction.

When underwater, beware of yellow dots on your threat display. These represent Subfighters or Attack Subs. On the surface beware of Gray dots, as these represent attack boats or cruisers. Use ECM torpedoes to decoy enemy torpedo fire when attacking large Submarines. When Surfaced, speed is your greatest asset. Use ECM missiles to decoy enemy missiles and use your Homing missiles to destroy enemies at a distance where possible. Destroy buildings and installations whenever you can - they may hold ammunition re-supplies or repairs.

Mission Two

Proceed into the Cone of Mount Fuji through the entry corridor, firing off an ECM missile to distract enemy fire. Follow your first waypoint indicator to the left. Submerge and attack the Sonar at this location. Proceed around the area on the far side of the Lava stream, destroying the Taps and engaging enemy subfighters as necessary. Several Torpedo firing Subfighters are present so use ECM as necessary. At the far end of the Lava chan-

nel destroy a second Sonar. Proceed around the mission zone, destroying a total of Four Russian Geothermal taps. After destroying the final tap, exit the Volcano swiftly before you are caught in the eruption.

SAVING A GAME

At the successful completion of each mission, you will have the option of saving your game. If you have a Memory Card you can insert it and choose one of eight slots in which to save your game. Highlight the slot you want and press the Start Button to select it. Use UP and DOWN on the Dpad to change letters and press LEFT/RIGHT to move to the next or previous letter. Press the Start Button to save the game. Whether or not you have a Memory Card, you will be given a five character password which can be entered at the Restore Game screen to bring you back to the same point in your game. If you restore a game using password or Memory Card, you will start play with the next mission following your most recently completed mission.

STRATEGY AND TACTICS

Tactical hints from Commander Wikan:

Use ECM missiles to decoy enemy missiles while you engage surface units. Often, it is a good idea to launch an ECM missile as soon as you surface.

- Do not get too close to enemy ships or they will engage you with Cannon - which is a recipe for serious systems damage.
- Finish off damaged enemies. A cripple can be just as dangerous as an intact enemy.
- DESTROY ALL SONARS AND RADARS YOU FIND. Alert zones are tied to sonar or radar installations. Knock out the warning systems and your life will be easier - and longer.
- Kill enemy carriers from a distance if you can. This will keep their unlaunched fighters off your back.
- Watch your threat indicator. It will save your life.
- Do not stop anywhere near an intact weapon emplacement.
- Watch which weapon you are firing. Running out of EMP torpedoes can ruin your day... and end all life on Earth as we know it.
- If you are having difficulty underwater, move slowly while clearing out specific areas of enemies before proceeding toward your target.

TECHNICAL SUPPORT (U.S. & CANADA)

If you experience problems running or playing this product, you can use any of the following avenues to obtain assistance:

Assistance Via World Wide Web

Get up-to-the-minute technical information at the GT Interactive Software web-site, at <http://www.gtinteractive.com>, 24 hours a day, seven days a week. In the **Support** section you'll have access to our **FAQ** documents, (Frequently Asked Questions) which contains our latest troubleshooting information. You can also visit our **Forums** area, where you can swap email with other gamers, our **FTP** (File Transfer Protocol) area where you can download patches and new enhancements as soon as they become available, our **Hints/Cheat Codes** area where you can pick up some tips, an **E-Mail** area where you can leave us your tech support problems and questions, and other areas where you can get valuable information on GT Interactive Software products.

Help Via Telephone In The United States & Canada

For phone assistance, call GT Interactive Software's **Tech Support** at **970-522-1797**. We have an **Interactive Voice Response** and **Faxback** system that is available 24 hours a day, seven days a week. If you should need live support, we are available Monday through Friday, 8 AM until Midnight (EST). Please note that live Tech Support may be closed on major holidays. We ask that you do the following when calling: be at your computer; have your system information ready for our technicians including system make and model; RAM; video and sound card data and drivers; and any screen or error messages you've encountered and where (if not currently displayed on your screen). It will expedite your handling significantly.

Help Via Mail In The United States & Canada

In the event our technicians at **970-522-1797** determine that you will need to forward materials directly to us, please include a brief letter explaining what is enclosed and why. Make sure you include the Return Authorization Number supplied you by the technician and your telephone number in case we need to call you. Any materials not containing this RMA# will be returned to you un-processed. Your mail should be sent to the following address:

GT Interactive Software
Attn: TS/QA
1 Nixon Lane
Edison, NJ 08817

TECHNICAL SUPPORT (EUROPE)

Help Via Telephone In Europe

Technical Assistance: English speaking customers call 01923
209145

Assistance Technique: Remarque: Notre service de soutien technique se trouve en Angleterre. Clients francophones appelez le
00 44 1923 209148

Technischer Kundendienst: Beachten Sie bitte dass sich unser technischer kundendienst in England befindet. Den deutschsprachigen Kundendienst erreichen Sie unter folgender Nummer:

00 44 1923 209151

CREDITS

LEAD PROGRAMMER
CORE PROGRAMMERS
GAME DESIGNER
ART DIRECTOR
3D ARTISTS

CINEMATIC ARTISTS
SOUND DESIGN and
CINEMATIC SCORING
GAME SOUNDTRACK-
MAC ATTACK PRODUCTIONS
GAME CONCEPT
EXECUTIVE PRODUCER
PRODUCER
ADDITIONAL PROGRAMMING
MANUAL DESIGN
GAME TESTERS

SPECIAL THANKS

TO OUR FAMILIES AND LOVED ONES
TIGERSHARK PC
LEAD PROGRAMMER
CORE PROGRAMMERS
for GTInteractive
PRODUCER
PRODUCT MANAGER
SPECIAL THANKS

Sean Purcell
Chris Cammack
Mike Wikan
Scott Cook
Brad Weckman
Jamie Gunter-Boulware
John Baurley

Russell Lieblich

Jeff Mac
Mike Wikan
Erick S. Dyke
Scott Berfield
John M. Meyers
Scott Berfield
Ernie Campbell
Julien Campbell
Brad Pauling
Dan O'Leary
Hiromi Nobata
Mackie Designs
Frank Delise
Gary Yost

Sean Waldron
Shawn Leaf

Dante Anderson
Tony Kee
Richard Davis
Cormac Russel
Chris Garske
Greg Fleming
Jason Schreiber
Kristine Severson

Tom McCann

Ted Newman
Carl Juliao

Aaron Sain
Chris Cammack

Sean Waldron
Mike Wikan
Kevin Campbell
Gus Sepulveda
Andrew Barch
Clyde Grossman
Patti Osterhout
The Asoft Gang
Troy Pope
Sarah Mason

Don Llopis

Stewart Kosoy
Asif Chaudri
Holly Newman
Arvee Garde
Rachel Olhava
Kathleen Lynch

Chris Otto

Stacy Schulstrom
Chris Stone

Don Llopis
Chris Nicolella
Trevor Sinclair
Brian Robinson
Chris Cabrera
Lynn Lupo
Rick Kelly
Lance Campbell
Bob Hichborn
Carlos Herrera

Max Taylor
Stephanie Shulman
Nic Lavroff
Joe Sousa
Kathleen Silkworth

Copyright Notice

Tigershark™ © 1997 n-Space, Inc. All Rights Reserved. Created by n-Space, Inc.
Distributed by GT Interactive Software Corp. GT™ is a trademark and the GT Logo® is a
registered trademark of GT Interactive Software Corp. n-Space™ and the n-Space Logo™
are trademarks of n-Space, Inc.



TigerShark™ © 1997 n-Space, Inc.* All Rights Reserved. Created by n-Space, Inc. Published and distributed by GT Interactive Software Corp. GT™ is a trademark and the GT Logo® is a registered trademark of GT Interactive Software Corp. n-Space™ and the n-Space Logo™ are trademarks of n-Space, Inc. All other trademarks are the property of their respective companies.

Licensed by Sony Computer Entertainment America for use with the PlayStation game console. PlayStation and the PlayStation logos are trademarks of Sony Computer Entertainment Inc. The ratings icon is a trademark of the Interactive Digital Software Association. Manufactured and printed in the U.S.A. THIS SOFTWARE IS COMPATIBLE WITH PLAYSTATION GAME CONSOLES WITH THE NTSC U/C DESIGNATION. U.S. AND FOREIGN PATENTS PENDING.

